

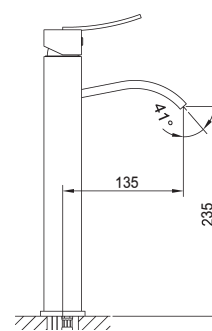

Série SYRACUSE

GARANTIE
10
ANS

FICHE TECHNIQUE

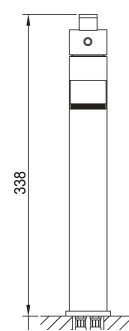
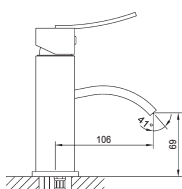
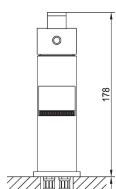

MITIGEUR LAVABO

Bec équipé d'un brise-jet
Cartouche Ø 35 mm KEROX
Flexibles d'alimentation inox G 3/8
Livré avec bonde à tirette G1" 1/4

Réf. SY11

Gencod. 3472827811003

MITIGEUR LAVABO HAUT

Bec équipé d'un brise-jet
Cartouche Ø 35 mm KEROX
Flexibles d'alimentation inox G 3/8
Livré sans bonde

Réf. SY11H

Gencod. 3472828711005

Ozé

Le prêt à poser de qualité



Série SYRACUSE

GARANTIE
10
ANS

FICHE TECHNIQUE

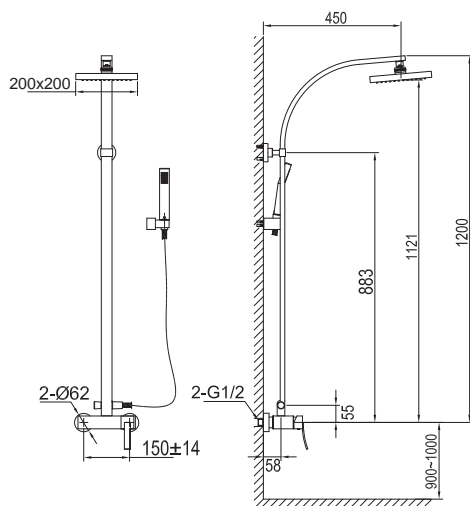

COLONNE DE DOUCHE SY500

Mitigeur mécanique cartouche Ø 35 mm KEROX
Barre en laiton
Pommeau de douche rond en ABS 200 x 200 mm sur rotule
Support douchette et douchette à main monojet amovible en ABS
Flexible double agrafage 1,50 m en inox

Réf. SY500
Gencod. 3472827850002

LES + DU PRODUIT

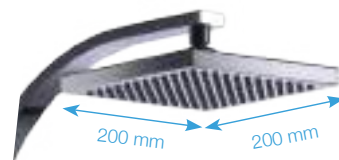

BARRE EN LAITON & DOUCHETTE AMOVIBLE



MITIGEUR DESIGN EN LAITON

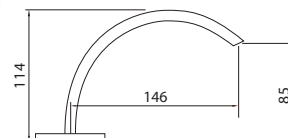
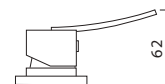
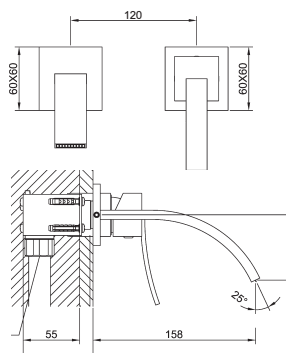

LAVABO MURAL

Bec équipé d'un brise-jet
Cartouche Ø 35 mm KEROX
Livré sans bonde

Réf. SY101

Gencod. 3472827801004



E-BOX

MITIGEUR LAVABO 2 TROUS

Bec équipé d'un brise-jet
Cartouche Ø 35 mm KEROX
Livré sans bonde

Réf. SY100

Gencod. 3472827800007

Ozé

Le prêt à poser de qualité



Série SYRACUSE

GARANTIE
10
ANS

FICHE TECHNIQUE

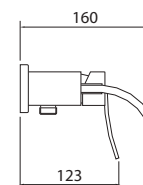
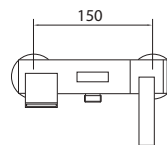
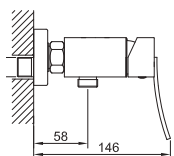
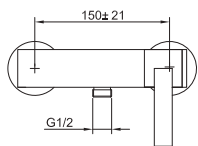

MITIGEUR DOUCHE

Cartouche Ø 35 mm KEROX

Réf. SY57

Gencod. 3472827857001

MITIGEUR BAIN DOUCHE

Bec équipé d'un brise-jet
Cartouche Ø 35 mm KEROX
Inverseur

Réf. SY33

Gencod. 3472827833005

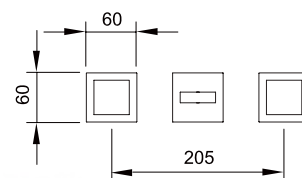
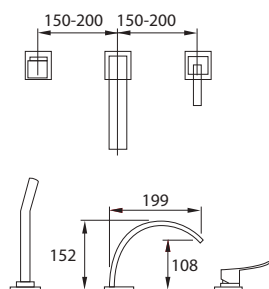

MITIGEUR BAIN DOUCHE 3 TROUS

Bec équipé d'un brise-jet
Cartouche Ø 35 mm KEROX
Douchette à main en ABS
Flexible de douche en INOX

Réf. SY300

Gencod. 3472827830004

MÉLANGEUR DOUCHE ENCASTRÉ 2 VOIES

Inverseur
Livré avec corps à encastrer
Modèle non équipé d'e-box

Réf. SY504

Gencod. 3472822366010

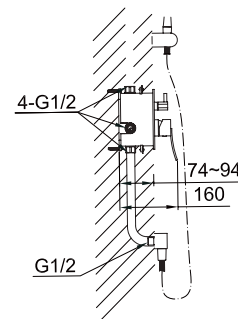
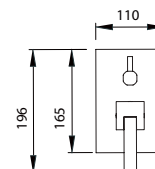
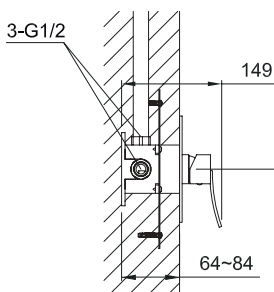
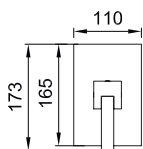

MITIGEUR DOUCHE ENCASTRÉ 1 VOIE

Cartouche Ø 40 mm KEROX
Sans inverseur
Livré avec corps à encastrer

Réf. SY904

Gencod. 3472822335016



E-BOX

MITIGEUR DOUCHE ENCASTRÉ 2 VOIES

Cartouche Ø 40 mm KEROX
Inverseur
Livré avec corps à encastrer

Réf. SY903

Gencod. 3472822336013



E-BOX

Ozé

Le prêt à poser de qualité



Série SYRACUSE

GARANTIE
10
ANS

FICHE TECHNIQUE

ENSEMBLE MITIGEUR DOUCHE ENCASTRÉ 1 VOIE ET POMMEAU DE DOUCHE

Cartouche Ø 35 mm KEROX
Pommeau de douche carré 200 x 200 mm en ABS
Bras 410 mm en laiton
Livré avec corps à encastrer

Réf. SY501

Gencod. 3472827851009



E-BOX

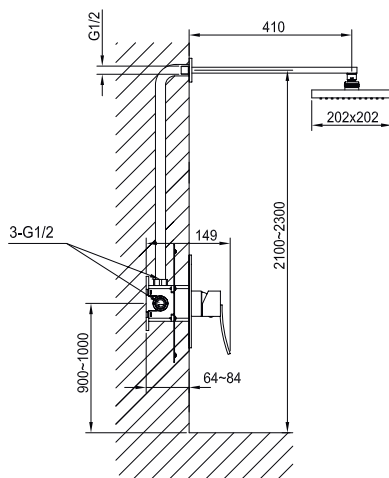

ENSEMBLE MITIGEUR DOUCHE ENCASTRÉ 2 VOIES

Cartouche Ø 35 mm KEROX
Pommeau de douche carré 200 x 200 mm en ABS
Bras 410 mm en laiton
Duplex en ABS
Connexion murale en laiton
Livré avec corps à encastrer

Réf. SY502

Gencod. 3472827852006



E-BOX

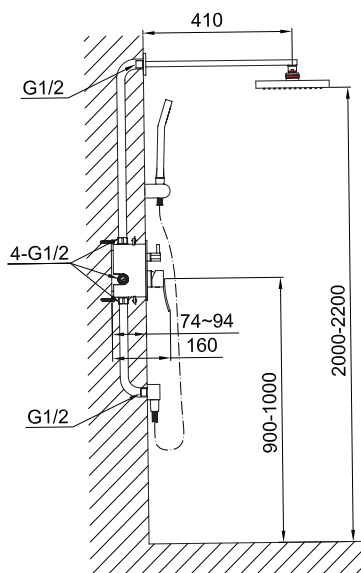

ENSEMBLE MÉLANGEUR DOUCHE ENCASTRÉ 2 VOIES

Soupapes 1/2 tour
Pommeau de douche carré 200 x 200 mm en ABS
Bras 410 mm en laiton
Duplex en ABS
Connexion murale en laiton
Livré avec corps à encastrer

Réf. SY503

Gencod. 3472827850309



E-BOX



Ozé

Le prêt à poser de qualité